

WEBENCH® Design Report

 Design : 1 LM2596SX-5.0/NOPB
 LM2596SX-5.0/NOPB 20.0V-32.0V to 5.00V @ 1.5A

Electrical BOM

Name	Manufacturer	Part Number	Properties	Qty	Price	Footprint
Cf	Samsung Electro-Mechanics	CL21C332JAFNNNE Series= C0G/NP0	Cap= 3.3 nF VDC= 25.0 V IRMS= 0.0 A	1	\$0.04	 0805 7 mm ²
Cin	TDK	C1608X5R1H105K080AB Series= X5R	Cap= 1.0 µF ESR= 5.522 mOhm VDC= 50.0 V IRMS= 2.2162 A	3	\$0.03	 0603 5 mm ²
Cout	AVX	TPSA475K010R1400 Series= TPS	Cap= 4.7 µF ESR= 1.4 Ohm VDC= 10.0 V IRMS= 208.0 mA	1	\$0.12	 3216-18 11 mm ²
D1	Fairchild Semiconductor	SS26FL	VF@Io= 700.0 mV VRRM= 60.0 V	1	\$0.10	 SOD-123F 12 mm ²
L1	Bourns	SRR1210-820M	L= 82.0 µH DCR= 110.0 mOhm	1	\$0.50	 SRR1210 196 mm ²
U1	Texas Instruments	LM2596SX-5.0/NOPB	Switcher	1	\$1.80	 TS5B 199 mm ²

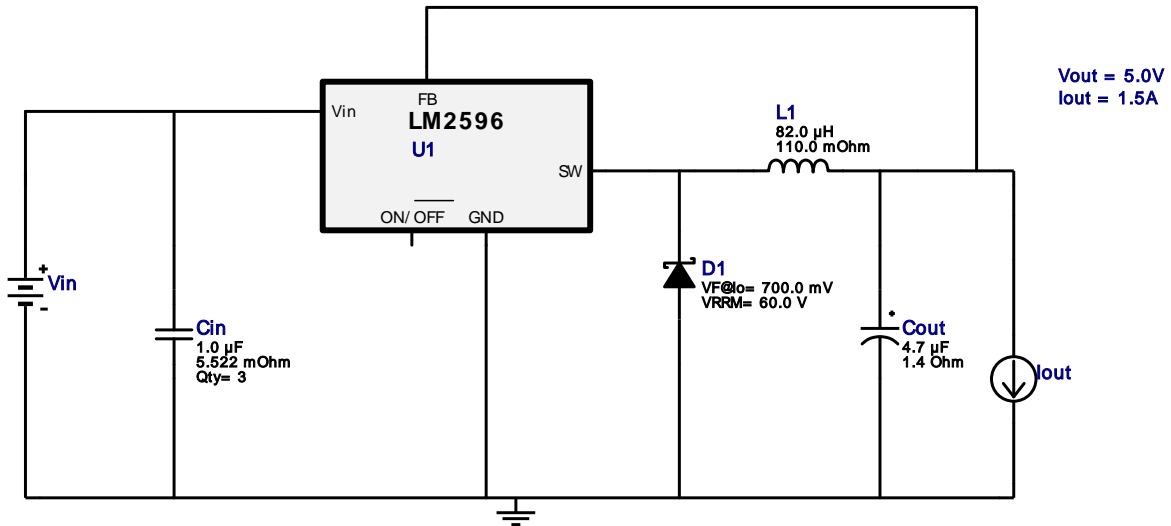
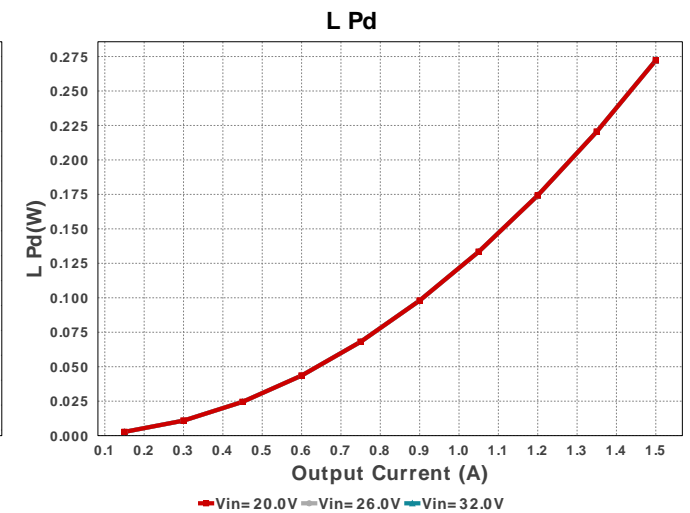
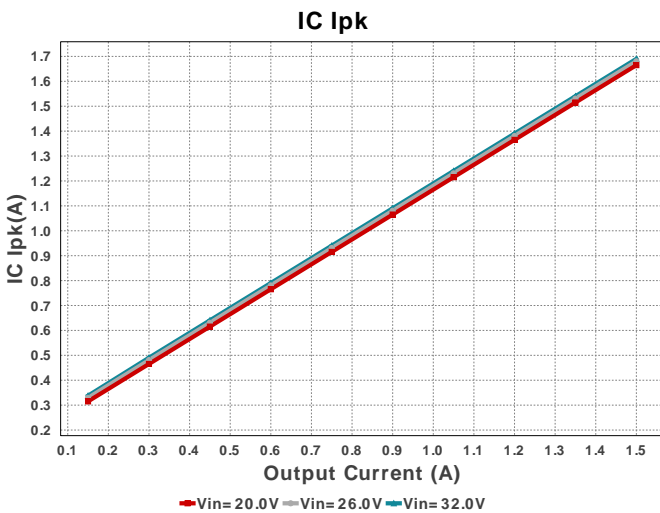
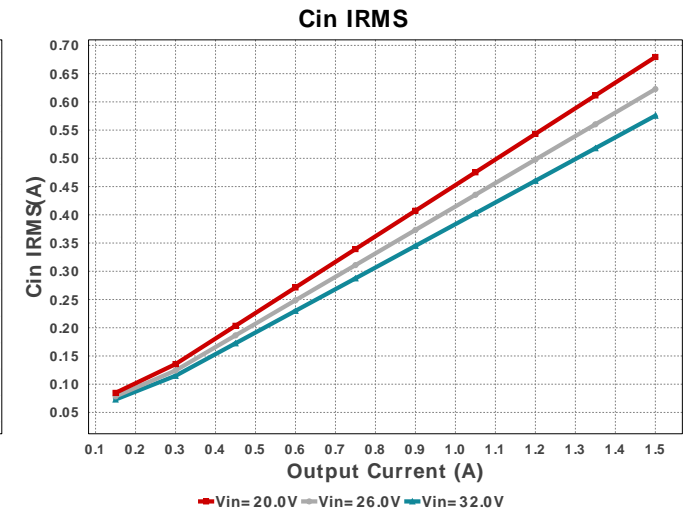
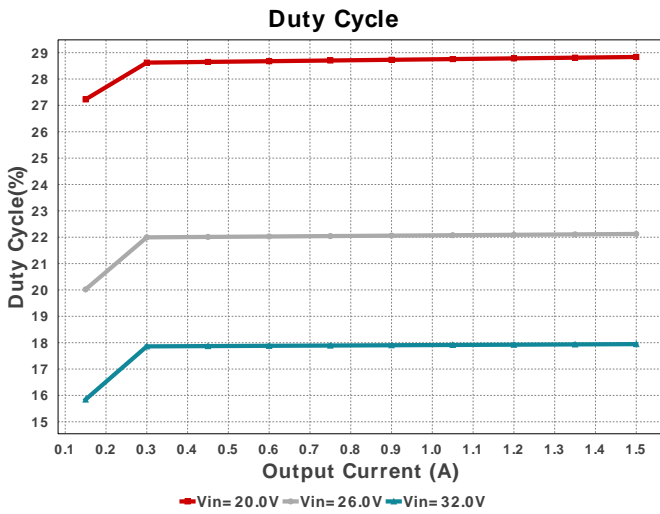
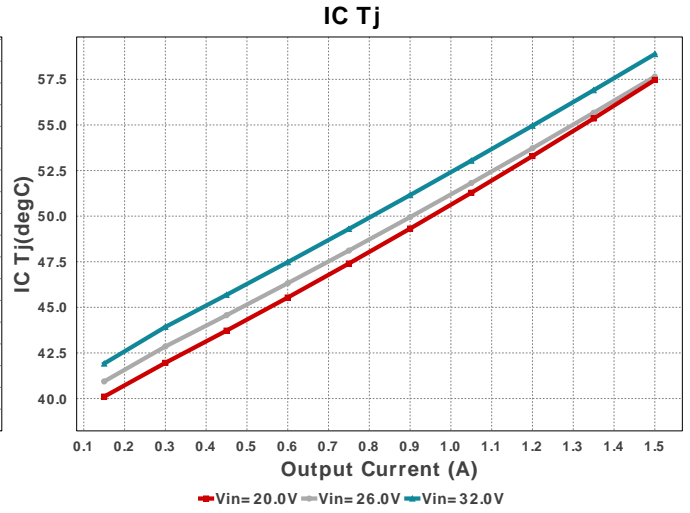
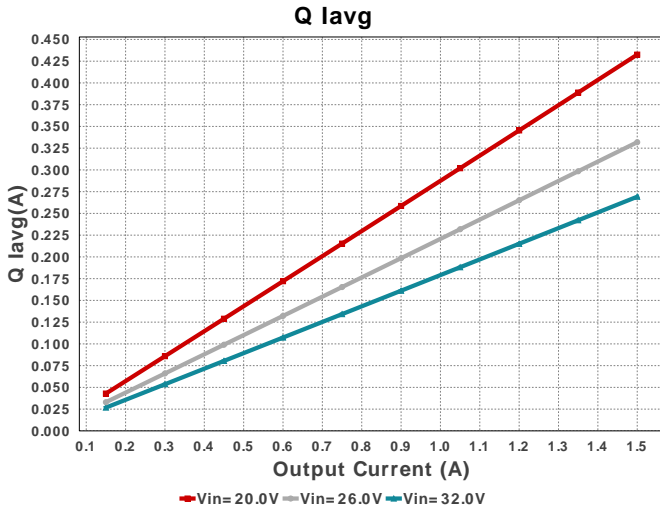
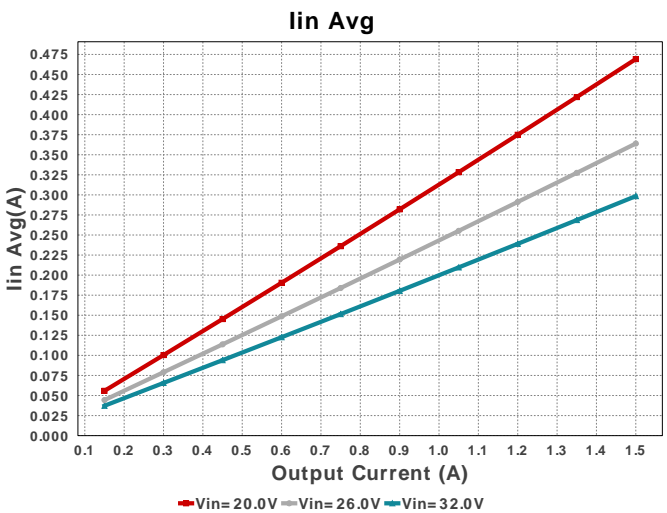
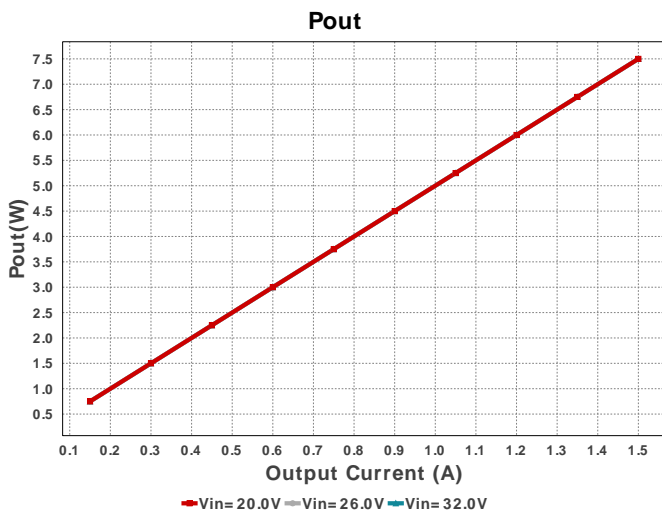
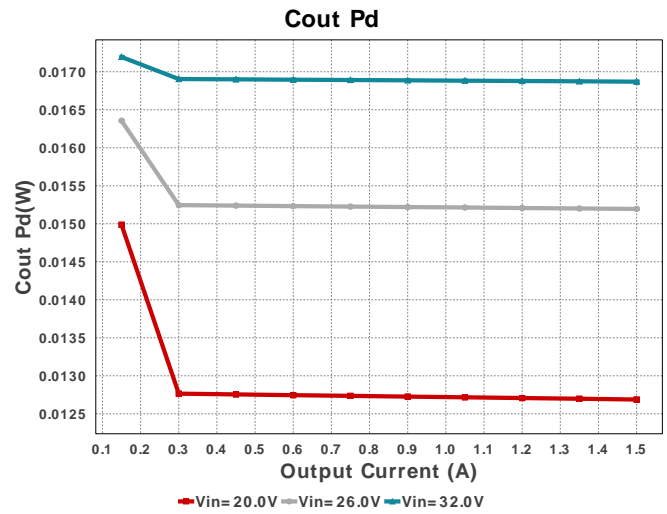
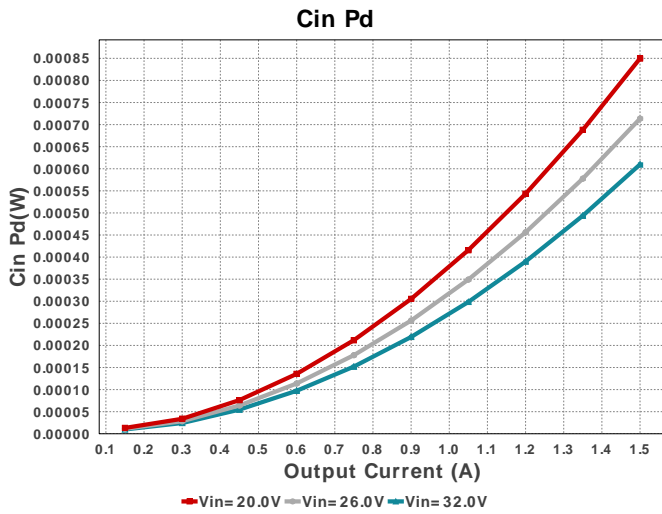
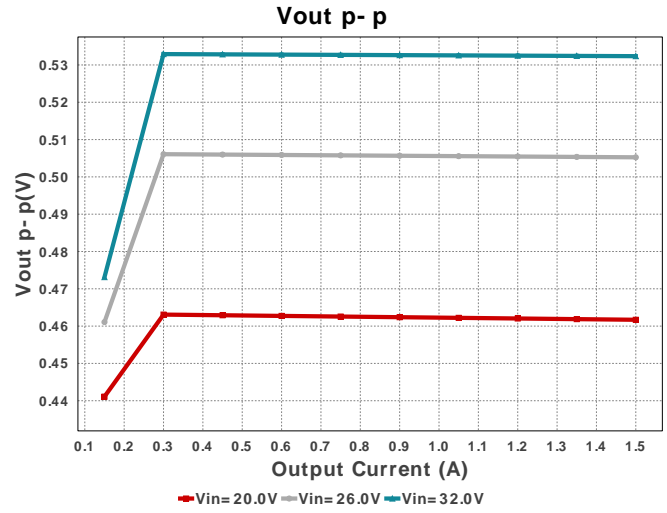
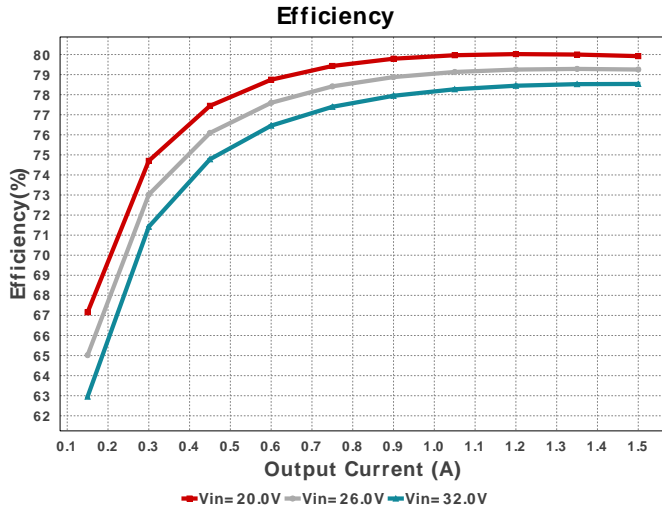

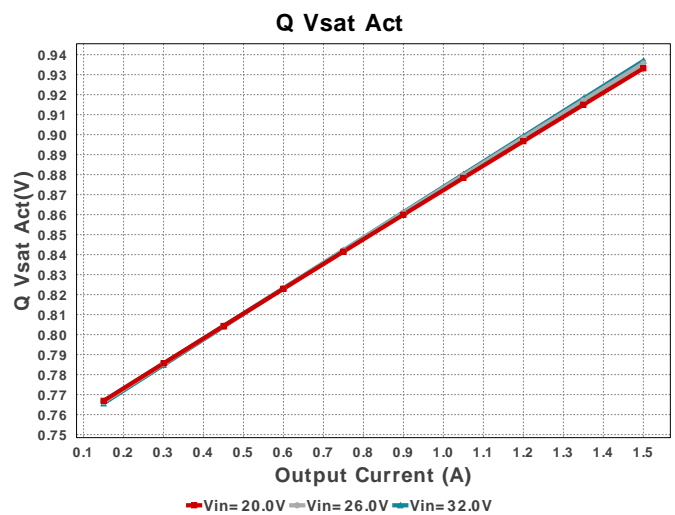
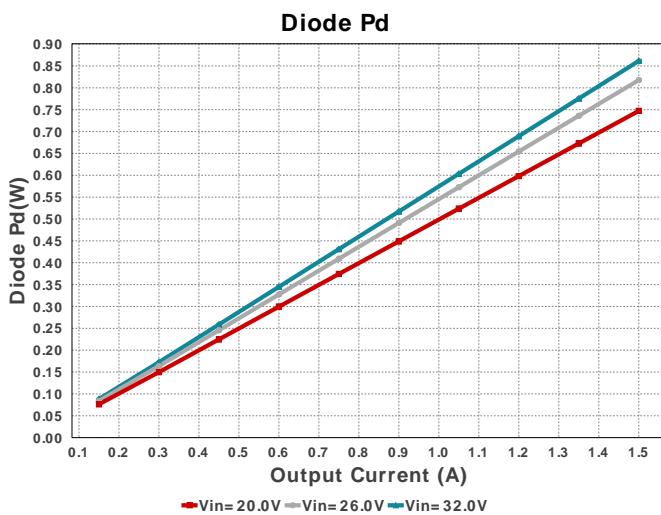
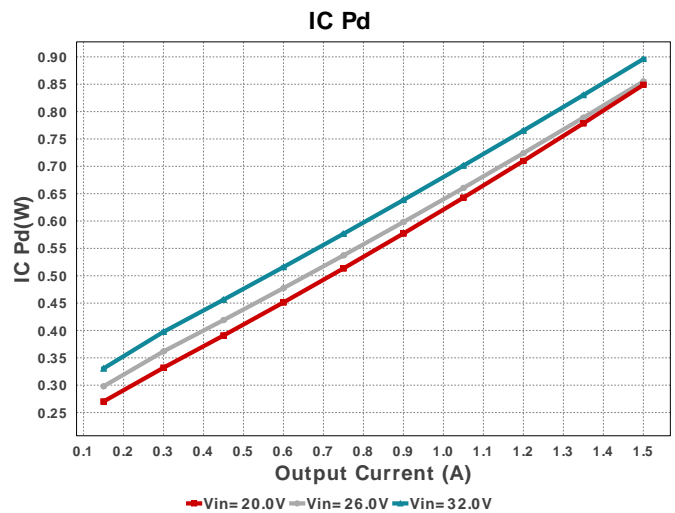
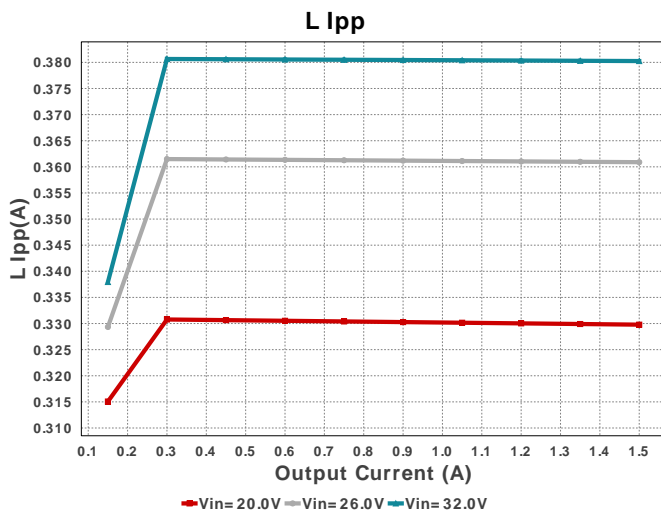
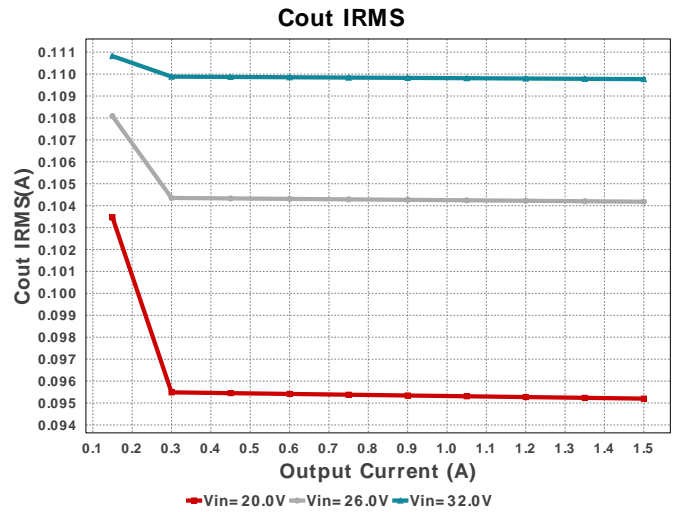
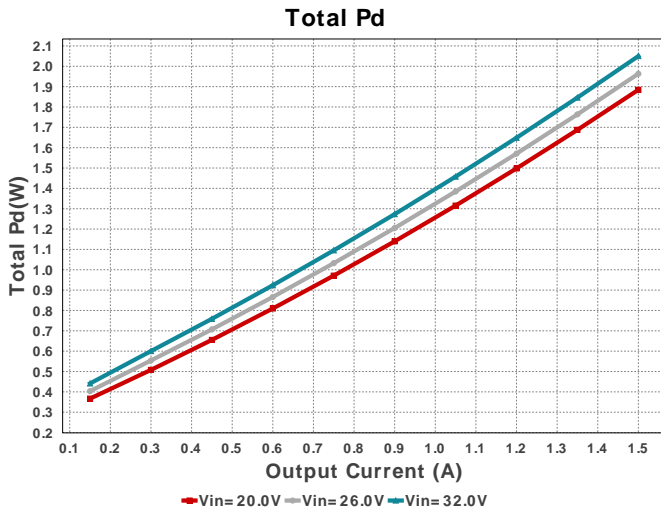



Operating Values

#	Name	Value	Category	Description
1.	Cin IRMS	575.597 mA	Capacitor	Input capacitor RMS ripple current
2.	Cin Pd	609.84 μ W	Capacitor	Input capacitor power dissipation
3.	Cout IRMS	109.77 mA	Capacitor	Output capacitor RMS ripple current
4.	Cout Pd	16.869 mW	Capacitor	Output capacitor power dissipation
5.	Diode Pd	861.57 mW	Diode	Diode power dissipation
6.	IC Ipk	1.69 A	IC	Peak switch current in IC
7.	IC Pd	896.17 mW	IC	IC power dissipation
8.	IC Tj	58.885 degC	IC	IC junction temperature
9.	IC Tolerance	0.0 V	IC	IC Feedback Tolerance
10.	ICThetaJA	30.0 degC/W	IC	IC junction-to-ambient thermal resistance
11.	Iin Avg	298.67 mA	IC	Average input current

#	Name	Value	Category	Description
12.	L Ipp	380.25 mA	Inductor	Peak-to-peak inductor ripple current
13.	L Pd	272.25 mW	Inductor	Inductor power dissipation
14.	Q Iavg	269.18 mA	Mosfet	Q Iavg
15.	Cin Pd	609.84 μ W	Power	Input capacitor power dissipation
16.	Cout Pd	16.869 mW	Power	Output capacitor power dissipation
17.	Diode Pd	861.57 mW	Power	Diode power dissipation
18.	IC Pd	896.17 mW	Power	IC power dissipation
19.	L Pd	272.25 mW	Power	Inductor power dissipation
20.	Total Pd	2.057 W	Power	Total Power Dissipation
21.	BOM Count	8	System	Total Design BOM count
22.	Duty Cycle	17.945 %	System Information	Duty cycle
23.	Efficiency	78.473 %	System Information	Steady state efficiency
24.	FootPrint	438.0 mm ²	System Information	Total Foot Print Area of BOM components
25.	Frequency	150.0 kHz	System Information	Switching frequency
26.	Iout	1.5 A	System Information	Iout operating point
27.	Mode	CCM	System Information	Conduction Mode
28.	Pout	7.5 W	System Information	Total output power
29.	Total BOM	\$2.65	System Information	Total BOM Cost
30.	Vin	32.0 V	System Information	Vin operating point
31.	Vout p-p	532.355 mV	System Information	Peak-to-peak output ripple voltage
32.	Q Vsat Act	936.886 mV	Transistor	Q Vsat

Design Inputs

Name	Value	Description
Iout	1.5	Maximum Output Current
VinMax	32.0	Maximum input voltage
VinMin	20.0	Minimum input voltage
Vout	5.0	Output Voltage
base_pn	LM2596	Base Product Number
source	DC	Input Source Type
Ta	32.0	Ambient temperature

WEBENCH® Assembly

Component Testing

Some published data on components in datasheets such as Capacitor ESR and Inductor DC resistance is based on conservative values that will guarantee that the components always exceed the specification. For design purposes it is usually better to work with typical values. Since this data is not always available it is a good practice to measure the Capacitance and ESR values of C_{in} and C_{out} , and the inductance and DC resistance of L1 before assembly of the board. Any large discrepancies in values should be electrically simulated in WEBENCH to check for instabilities and thermally simulated in WebTHERM to make sure critical temperatures are not exceeded.

Soldering Component to Board

If board assembly is done in house it is best to tack down one terminal of a component on the board then solder the other terminal. For surface mount parts with large tabs, such as the DPAK, the tab on the back of the package should be pre-tinned with solder, then tacked into place by one of the pins. To solder the tab down to the board place the iron down on the board while resting against the tab, heating both surfaces simultaneously. Apply light pressure to the top of the plastic case until the solder flows around the part and the part is flush with the PCB. If the solder is not flowing around the board you may need a higher wattage iron (generally 25W to 30W is enough).

Initial Startup of Circuit

It is best to initially power up the board by setting the input supply voltage to the lowest operating input voltage 20.0V and set the input supply's current limit to zero. With the input supply off connect up the input supply to V_{in} and GND. Connect a digital volt meter and a load if needed to set the minimum load of the design from V_{out} and GND. Turn on the input supply and slowly turn up the current limit on the input supply. If the voltage starts to rise on the input supply continue increasing the input supply current limit while watching the output voltage. If the current increases on the input supply, but the voltage remains near zero, then there may be a short or a component misplaced on the board. Power down the board and visually inspect for solder bridges and recheck the diode and capacitor polarities. Once the power supply circuit is operational then more extensive testing may include full load testing, transient load and line tests to compare with simulation results.

Load Testing

The setup is the same as the initial startup, except that an additional digital voltmeter is connected between V_{in} and GND, a load is connected between V_{out} and GND and a current meter is connected in series between V_{out} and the load. The load must be able to handle at least rated output power + 50% (7.5 watts for this design). Ideally the load is supplied in the form of a variable load test unit. It can also be done in the form of suitably large power resistors. When using an oscilloscope to measure waveforms on the prototype board, the ground leads of the oscilloscope probes should be as short as possible and the area of the loop formed by the ground lead should be kept to a minimum. This will help reduce ground lead inductance and eliminate EMI noise that is not actually present in the circuit.



Design Assistance

1. Master key : 52094E7166C9EDB2[v1]
2. **LM2596** Product Folder : <http://www.ti.com/product/LM2596> : contains the data sheet and other resources.

Important Notice and Disclaimer

TI provides technical and reliability data (including datasheets), design resources (including reference designs), application or other design advice, web tools, safety information, and other resources AS IS and with all faults, and disclaims all warranties. These resources are intended for skilled developers designing with TI products. You are solely responsible for (1) selecting the appropriate TI products for your application, (2) designing, validating and testing your application, and (3) ensuring your application meets applicable standards, and any other safety, security, or other requirements.

These resources are subject to change without notice. TI grants you permission to use these resources only for development of an application that uses the TI products described in the resource. Other reproduction and display of these resources is prohibited. No license is granted to any other TI intellectual property right or to any third party intellectual property right. TI disclaims responsibility for, and you will fully indemnify TI and its representatives against, any claims, damages, costs, losses, and liabilities arising out of your use of these resources.

Providing these resources does not expand or otherwise alter TI's applicable Terms of Sale or other applicable terms available either on ti.com or provided in conjunction with TI products.